

OPERATING INSTRUCTIONS

EN

Translation of the original instructions

IKR 251

Compact Cold Cathode Gauge, FPM gedichtet

Product Identification

In all communications with Pfeiffer Vacuum, please specify the information given on the product nameplate.

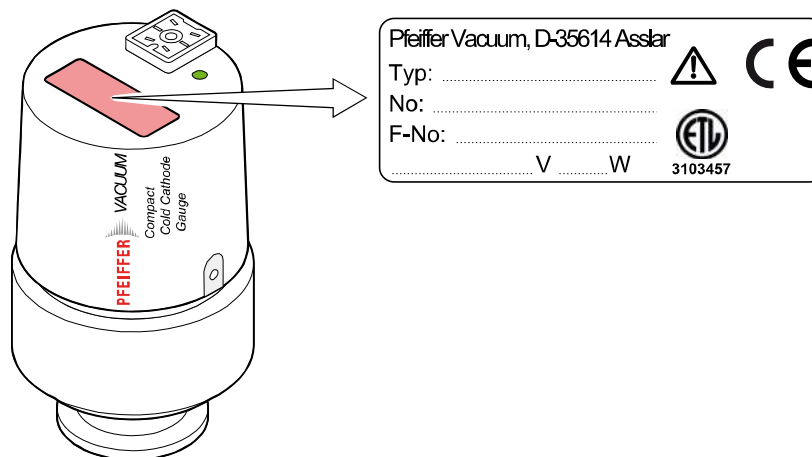

Validity

This document applies to products with the following part numbers

PT R25 500	(DN 25 ISO-KF flange)
PT R25 501	(DN 40 ISO-KF flange)
PT R25 502	(DN 40 CF-F flange)

The part number can be taken from the product nameplate.

We reserve the right to make technical changes without prior notice.

Intended Use

The Compact Cold Cathode Gauge IKR 251 has been designed for vacuum measurement in a pressure range of 2×10^{-9} ... 1×10^{-2} hPa.

The IKR 251 can be used with a Pfeiffer Vacuum measurement unit for Compact Gauges or with another evaluation unit.



Functional Principle

Over the whole measurement range, the measuring signal is output as a logarithm of the pressure.

If functions with a cold cathode ionization measurement circuit (according to the inverted magnetron principle).

Contents

Product Identification	2
Validity	2
Intended Use	2
Functional Principle	2
1 Safety	4
1.1 Symbols Used	4
1.2 Personnel Qualifications	4
1.3 Safety Information	4
1.4 Liability and Warranty	5
2 Technical Data	6
3 Installation	9
3.1 Vacuum Connection	9
3.1.1 Removing the Magnet Unit (Only for Gauges With CF Flanges)	10
3.2 Power Connection	11
3.2.1 Use With a Pfeiffer Vacuum Measurement Unit	11
3.2.2 Use With Another Evaluation Unit	11
4 Operation	13
5 Maintenance	14
5.1 Cleaning the Gauge / Replacing Parts	14
5.1.1 Disassembling the Gauge	15
5.1.2 Cleaning the Gauge	16
5.1.3 Reassembling the Gauge	16
5.1.4 Adjusting the Gauge	17
5.2 What to Do in Case of Problems	18
6 Removing the Gauge From the Vacuum System	18
7 Returning the Product	19
8 Accessories	19
9 Spare Parts	20
10 Disposal	20
Appendix	21
A: Conversion Table for Pressure Units	21
B: Measuring Signal vs. Pressure	21
C: Gas Type Dependence	22
ETL Certification	23

For cross references within this document, the symbol (→  XY) is used, for references to other documents, the symbol (→  [Z]).

1 Safety

1.1 Symbols Used



DANGER

Information on preventing any kind of physical injury.



WARNING

Information on preventing extensive equipment and environmental damage.



Caution

Information on correct handling or use. Disregard can lead to malfunctions or minor equipment damage.

1.2 Personnel Qualifications



Skilled personnel

All work described in this document may only be carried out by persons who have suitable technical training and the necessary experience or who have been instructed by the end-user of the product.

1.3 Safety Information

- Adhere to the applicable regulations and take the necessary precautions for the process media used.
Consider possible reactions between the materials (→ 7) and the process media.
Consider possible reactions of the process media due to the heat generated by the product.
- Adhere to the applicable regulations and take the necessary precautions for all work you are going to do and consider the safety information in this document.
- Before you begin to work, find out whether any vacuum components are contaminated. Adhere to the relevant regulations and take the necessary precautions when handling contaminated parts.



DANGER



DANGER: magnetic fields

Strong magnetic fields can disturb electronic devices like heart pacemakers or impair their function.



Maintain a safety distance of ≥ 10 cm between the magnet and the heart pacemaker or prevent the influence of strong magnetic fields by antimagnetic shielding.

Pass on the safety information to other users.

1.4 Liability and Warranty

Pfeiffer Vacuum assumes no liability and the warranty becomes null and void if the custodian or third parties

- disregard the information in this document
- use the product in a non-conforming manner
- make any kind of changes (modifications, alterations etc.) to the product
- use the product with accessories not listed in the corresponding product documentation.

The custodian assumes the responsibility in conjunction with the process media used.

Gauge failures due to contamination or wear and tear, as well as expendable parts (e.g. seals), are not covered by the warranty.

2 Technical Data

Admissible temperatures	
Storage	-40 °C ... +65 °C
Operation	+5 °C ... +55 °C
Bakeout	+150 °C (without electronics unit and magnetic shielding)
Relative humidity	max. 80% at temperatures $\leq +31$ °C decreasing to 50% at +40 °C
Use	indoors only altitude up to 2000 m (6600 ft)
Measurement range (air, N ₂)	2×10^{-9} ... 1×10^{-2} hPa
Accuracy	$\approx \pm 30\%$ in the range 1×10^{-8} ... 1×10^{-3} hPa
Reproducibility	$\approx \pm 5\%$ in the range 1×10^{-8} ... 1×10^{-3} hPa
Gas type dependence	→ Appendix C
Adjustment	The gauge is adjusted at the factory and requires no maintenance.
Degree of protection	IP 40
Maximum pressure (absolute)	1000 kPa only for inert gases <55 °C
Supply	
<div style="display: flex; align-items: center; justify-content: center;">  <div style="margin-left: 10px;"> <p style="background-color: red; color: white; padding: 5px; display: inline-block;">STOP DANGER</p> <p>The gauge may only be connected to supply or measurement units that conform to the requirements of a grounded protective extra-low voltage (PELV). The connection to the gauge has to be fused.¹⁾</p> </div> </div>	
Voltage at the gauge	15.0 ... 30.0 VDC (max. ripple 1 V _{pp})
Power consumption	≤ 2 W
Fuse ¹⁾	≤ 1 AT
The minimum voltage of the power supply must be increased proportionally to the length of the measuring cable.	
Voltage at the supply unit with maximum cable length	16.0 ... 30.0 VDC (max. ripple 1 V _{pp})
Electrical connection	Hirschmann compact connector type GO 6, 6 pins, male
Tightening torque	≤ 0.2 Nm
Cable	5 poles plus screening
Maximum cable length	100 m (0.25 mm ² conductor) 150 m (0.34 mm ² conductor) 500 m (1.0 mm ² conductor)
Operating voltage (in the measuring chamber)	≤ 3.3 kV
Operating current (in the measuring chamber)	≤ 500 μ A

¹⁾ Pfeiffer Vacuum measurement and control units for Compact Gauges fulfill these requirements.

Output signal (measuring signal)	
Voltage range	≈ 0 V ... ≈ +10.5 V
Relationship voltage-pressure	logarithmic, increase 1 V / decade (→ Appendix B)
Error signals	<0.5 V (no supply)
Output impedance	2×10 Ω
Normal load	100 kΩ
Minimum load	10 kΩ, short-circuit proof
Response time	pressure dependent
p > 10 ⁻⁶ hPa	<10 ms
p = 10 ⁻⁸ hPa	≈ 1 s

Gauge identification 5.1 kΩ resistor referenced to supply common → Figure 2

Grounding concept → Figure 2

Vacuum flange-measurement common connected via 10 kΩ (max. voltage differential with respect to safety ±50 V with respect to accuracy ±10 V)

Supply common-signal common conducted separately; differential measurement recommended for cable lengths ≥10 m

PT R25 500 (DN 25 ISO-KF)

Materials exposed to the vacuum	
Feedthrough isolation	ceramic (Al ₂ O ₃)
Internal seals	FPM75
Flange	stainless steel (1.4104)
Measuring chamber	stainless steel (1.4104)
Anode	Mo
Ignition aid	stainless steel (1.4310/AISI 301)
Internal volume	≈20 cm ³

Dimensions [mm]

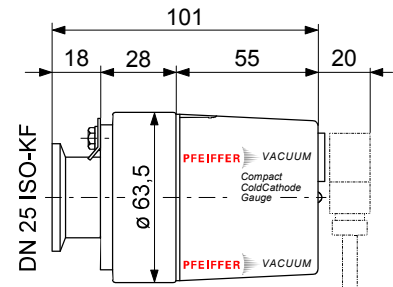

Weight 700 g

PT R25 501 (DN 40 ISO-KF)
 PT R25 502 (DN 40 CF-F)

Materials exposed to the vacuum

Feedthrough isolation	ceramic (Al ₂ O ₃)
Internal seals	FPM75
Flange	stainless steel (1.4306/AISI 304L)
Measuring chamber	stainless steel (1.4104)
Anode	Mo
Ignition aid	stainless steel (1.4310/AISI 301)

Internal volume ≈20 cm³

Dimensions [mm]

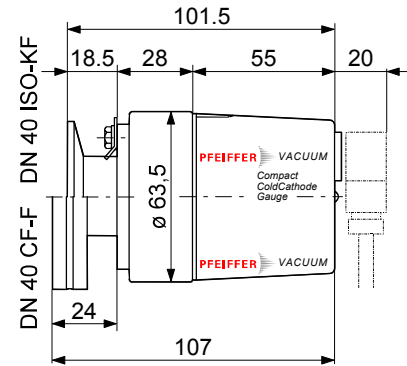

Weight

700 g (DN 40 ISO-KF flange)
 950 g (DN 40 CF-F flange)

3 Installation

3.1 Vacuum Connection



Caution



Caution: vacuum component

Dirt and damages impair the function of the vacuum component.

When handling vacuum components, take appropriate measures to ensure cleanliness and prevent damages.

The gauge can be mounted in any orientation. However, it should be mounted so that any particles present cannot penetrate into the measuring chamber (→ 13). See "Technical data" (→ 6 ff.) for space requirements.

Procedure

- 1 Remove the protective cap.



The protective cap will be needed for maintenance work.

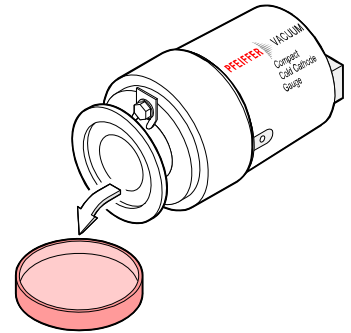

- 2 Make the flange connection.

When making a CF flange connection, it can be advantageous to temporarily remove the magnet unit (→ section 3.1.1).

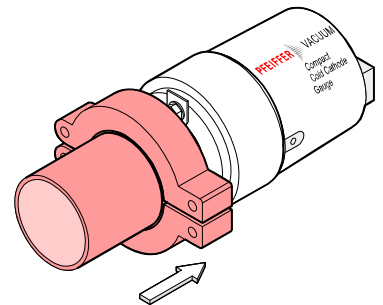

STOP DANGER



DANGER: overpressure in the vacuum system >250 kPa
KF flange connections with elastomer sealing rings (e.g. O-rings) cannot withstand such pressures. Process media can thus leak and possibly damage your health.

Use sealing rings provided with an outer centering ring.

STOP DANGER



DANGER: overpressure in the vacuum system >100 kPa
If clamps are opened unintentionally injury can be caused by catapulted parts.

Use the type of clamps which can only be opened and closed by means of a tool (e.g. hose clip clamping ring).

STOP DANGER

The gauge must be electrically connected to the grounded vacuum chamber. The connection must conform to the requirements of protective connection according to EN 61010:

- CF flanges fulfill this requirement
- For gauges with KF flanges, use a conductive metallic clamping ring.

**WARNING**

WARNING: electric arcing

Helium may cause electric arcing with detrimental effects on the electronics of the product.

Before performing any tightness tests put the product out of operation and remove the electronics unit.

3.1.1 Removing the Magnet Unit (Only for Gauges With CF Flanges)

Tools required

- Allen wrench AF 1.5
- Open-end wrench AF 7

Procedure

- 1 Unfasten the hexagon socket set screw (1) on the side of the electronics unit (2) (→ Figure 1).
- 2 Remove the electronics unit.
- 3 Unfasten the hexagon head screw (3) on the magnet unit (4) and remove the magnet unit.

**Caution**

The magnetic force and the tendency to tilt make it more difficult to separate the magnet unit and the measuring chamber (7).

- 4 Make the flange connection between the gauge and the vacuum system.
- 5 Remount the magnet unit and lock it with the hexagon head screw (3).
- 6 Carefully mount the electronics unit (2).
- 7 Push the electronics unit up to the mechanical stop and lock it with the hexagon socket set screw (1).

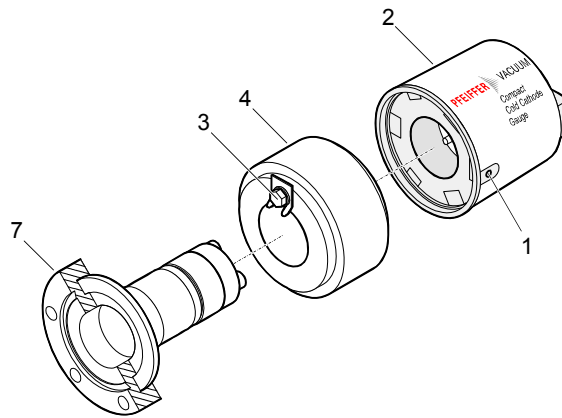

Figure 1

3.2 Power Connection

3.2.1 Use With a Pfeiffer Vacuum Measurement Unit

If the gauge is used with a Pfeiffer Vacuum measurement unit for Compact Gauges, a corresponding connection cable is required (→ 19).

- Secure the cable at the gauge with the screw (tightening torque ≤ 0.2 Nm).

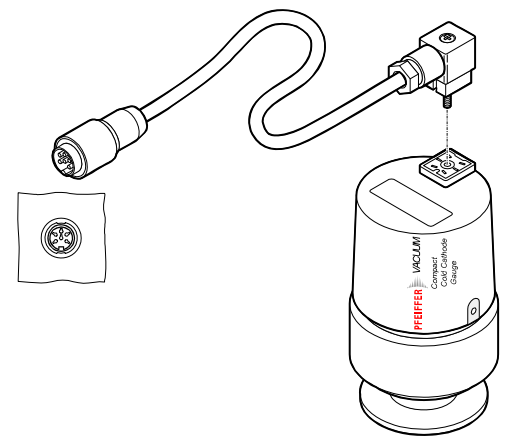

3.2.2 Use With Another Evaluation Unit

The gauge can also be operated with other evaluation units. In this case, an individual connection cable must be made.

For cable lengths up to 10 m (with a conductor cross-section of 0.34 mm^2), the measuring signal can be read directly between the positive signal output (pin 2) and the supply common (pin 5) without the degree of accuracy being lowered. For longer measurement cable lengths, we recommend a differential measurement between the signal output and the signal common (pin 3) (as a result of the voltage drop along the supply cable ground lead, the common mode signal is approx. 1.0 V at the maximum permissible cable length).

Procedure

- 1 Prepare the connector (Ordering number → 19).

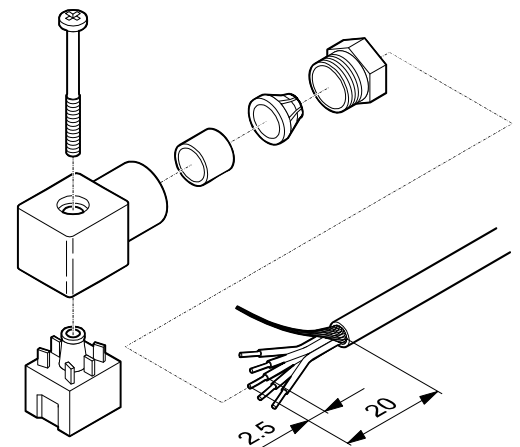

2 Solder the connection cable according to the diagram.

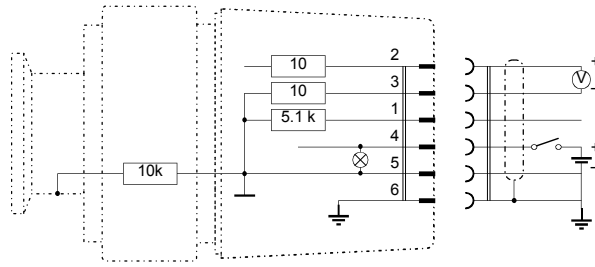
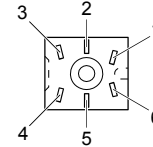

Figure 2: Power connection

- Pin 1 identification
- Pin 2 signal output (measuring signal)
- Pin 3 signal common
- Pin 4 supply
- Pin 5 supply common
- Pin 6 screen



Connector, soldering side

WARNING

The supply common (pin 5) and screen (pin 6) must be connected to the supply unit with protective ground. Incorrect connection, incorrect polarity, or inadmissible supply voltages can damage the gauge.

3 Reassemble the connector.

4 Plug in the connector.
Secure the cable on the gauge with the screw (tightening torque ≤ 0.2 Nm).

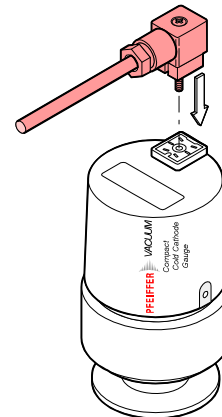

4 Operation

As soon as the required voltage is applied, the measuring signal is available between pins 2 and 3. (→ Appendix B for the relationship between the measuring signal and the pressure).

The green lamp on the gauge indicates the operating state:



Supply voltage present.



No supply voltage.



Caution



Turn on the gauge only at pressures $<10^{-2}$ hPa to prevent excessive contamination.

If you are using a Pfeiffer Vacuum measurement unit for Compact Gauges with at least two gauge connections, the cold cathode gauge can be controlled, for example, by a Pirani gauge.

Gas type dependence

The measuring signal depends on the type of gas being measured. The curves are accurate for dry air, N₂, O₂ and CO. They can be mathematically converted for other gases (→ Appendix C).

If you are using a Pfeiffer Vacuum measurement unit for Pfeiffer Vacuum Compact Gauges, you can enter a calibration factor to correct the measurement value displayed (→  of that measurement unit).

Ignition delay

An ignition delay occurs when cold cathode gauges are switched on. The delay time increases at low pressures and for clean, degassed gauges it is typically:

10^{-7} hPa	≈	0.1 minute
10^{-8} hPa	≈	1 minute
2×10^{-9} hPa	≈	5 minutes

The ignition is a statistical process. Already a small amount of depositions on the inner surfaces can have a strong influence on it.

Contamination

Gauge failures due to contamination or wear and tear, as well as expendable parts (e.g. seals), are not covered by the warranty.

Gauge contamination is influenced by the process media used as well as any existing or new contaminants and their respective partial pressures. Continuous operation in the range of 10^{-4} hPa ... 10^{-2} hPa can cause severe contamination as well as reduced up-time and maintenance cycles. With constantly low pressures ($< 1 \times 10^{-6}$ hPa), the gauge can be operated for more than one year without cleaning (cleaning the gauge →  16).

In general, contamination of the gauge leads to deviations of the measured values:

- In the low pressure range ($p < 1 \times 10^{-3}$ hPa), the pressure indication is usually too low (as a consequence of the contamination of the cold cathode system). In case of severe contamination, instabilities can occur (layers of the measuring chamber peel off). Contamination due to isolating layers can even lead to a complete failure of the discharge.

Contamination can to a certain extent be reduced by:

- geometric protection (e.g. screenings, elbows) against particles that spread rectilinearly
- mounting the flange of the gauge at a place where the partial pressure of the pollutants is particularly low.

Special precautions are required for vapors deposited under plasma (of the cold cathode measuring system). It may even be necessary to temporarily switch of the gauge while vapors occur.

5 Maintenance

Gauge failures due to contamination or wear and tear, as well as expendable parts (e.g. seals), are not covered by the warranty.



STOP DANGER

DANGER: contaminated parts

Contaminated parts can be detrimental to health and environment.

Before you begin to work, find out whether any parts are contaminated. Adhere to the relevant regulations and take the necessary precautions when handling contaminated parts.

5.1 Cleaning the Gauge / Replacing Parts



STOP DANGER

DANGER: cleaning agents

Cleaning agents can be detrimental to health and environment.

Adhere to the relevant regulations and take the necessary precautions when handling and disposing of cleaning agents. Consider possible reactions with the product materials (→ 7).

Tools / material required

- Allen wrench AF 1.5
- Allen wrench AF 3
- Open-end wrench AF 7
- Pliers for circlip
- Polishing cloth (400 grain) or Scotch-Brite
- Tweezers
- Cleaning alcohol
- Mounting tool for ignition aid
- Ignition aid
- FPM seal (11) for anode feedthrough

5.1.1 Disassembling the Gauge

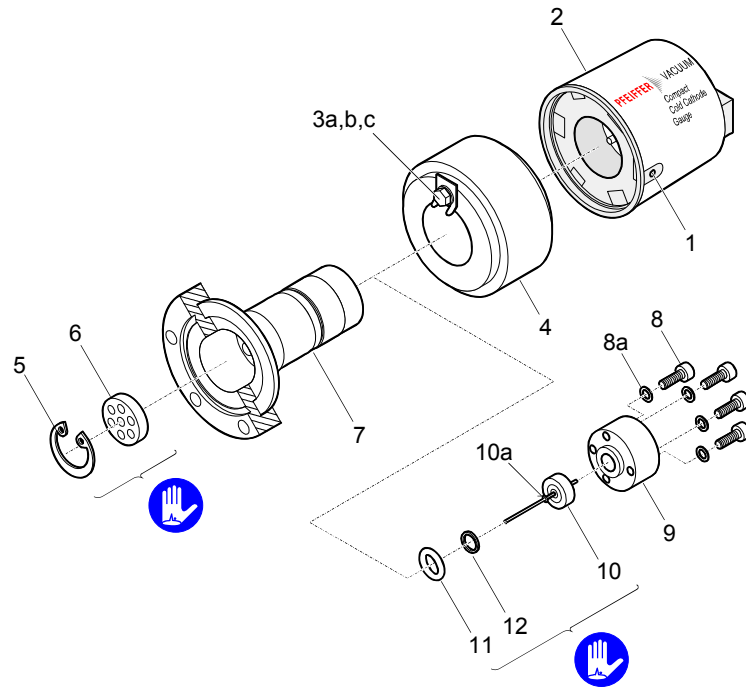

Figure 3

Procedure

- ➊ Remove the gauge from the vacuum system (→ 18).
- ➋ Unfasten the hexagon socket set screw (1) on the side of the electronics unit (2) (→ Figure 3).
- ➌ Remove the electronics unit.



Caution



The cover of the electronics unit cannot be removed.

- ➍ Unfasten the hexagon head screw (3) on the magnet unit (4) and remove the magnet unit.



Caution



The magnetic force and the tendency to tilt make it more difficult to separate the magnet unit and the measuring chamber (7).

- ➎ Remove the circlip (5) as well as the polarity insert (6) from the measuring chamber.
- ➏ Remove the four (or two) hexagon socket screws (8) incl. lock washers (8a) on the back of the measuring chamber.
- ➐ Carefully remove the following items in this order: pressure piece (9), complete anode (10), FPM seal (11) incl. support ring (12).

The parts can now be cleaned or replaced.

5.1.2 Cleaning the Gauge

Procedure

- Using a polishing cloth rub the inside walls of the measuring chamber and the polarity insert to a bright finish.

Caution





The sealing surfaces must only be worked concentrically.

- Rinse the measuring chamber and the polarity insert with cleaning alcohol.
- Allow both to dry.

Cleaning or replacing the anode:

- Remove the old ignition aid (10a) with tweezers (→ Figure 3).
- Using a polishing cloth rub the anode pin to a bright finish.

Caution



Do not bend the anode. Do not carry out mechanical work on the ceramic part.

- Rinse the anode with cleaning alcohol.
- Allow the anode to dry.
- Insert a new ignition aid (10a) into the mounting tool.
- Carefully press the anode (clean or new) centered and parallel to the tool axis into the ignition aid and insert it to a depth of approx. 15 mm. The final positioning is established after the anode is installed.

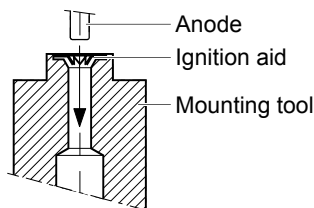

5.1.3 Reassembling the Gauge

Procedure

- Insert the FPM seal (11) with the support ring (12) centered into the measuring chamber. The sealing surface, seal, and ceramic part must be clean (→ Figure 3).
- Carefully insert the anode (10) incl. ignition aid (10a) into the measuring chamber.
- Carefully place the pressure piece (9) on the measuring chamber and tighten it **uniformly** with the four (or two) hexagon socket screws (8) incl. lock washers (8a) until the stop position is reached.

- 4 Position the ignition aid (10a) by pushing the mounting tool over the anode pin until the mechanical stop is reached.
- 5 Remove the particles in the measuring chamber with dry nitrogen (be careful to hold the measuring chamber with the flange pointing downwards).
- 6 Slide the polarity insert (6) into the measuring chamber up to the mechanical stop.
- 7 Place the circlip (5) snugly fitting on the polarity insert.

**Caution**

Visually check that the anode pin is centered over the middle hole of the polarity insert (max. eccentricity = 0.5 mm).

- 8 If possible perform a leak test (leak rate $<10^{-9}$ hPa l/s).

**WARNING**

WARNING: electric arcing

Helium may cause electric arcing with detrimental effects on the electronics of the product.

Before performing any tightness tests put the product out of operation and remove the electronics unit.

- 9 Mount the magnet unit (4) and lock it with the hexagon head screw (3).
- 10 Carefully slide the electronics unit (2) on the magnet unit until the mechanical stop is reached.
- 11 Fasten the electronics unit (2) by means of the hexagon socket set screw (1).

**DANGER**

Due to missing ground connection in conjunction with missing or not correctly tightened hexagon socket set screw (1) dangerous contact voltage will occur and electronic components will be damaged.

5.1.4 Adjusting the Gauge

The gauge is factory-calibrated and requires no maintenance. It must be replaced in the event of a defect (→ 20).

5.2 What to Do in Case of Problems

Problem	Possible cause	Correction
Measuring signal continually < 0.5 V and green lamp is OFF.	No supply voltage.	Turn on the power supply.
Measuring signal continually < 0.5 V and green lamp is ON	Supply voltage too low.	Increase the supply voltage (→ 6).
	Electronics unit defective.	Replace the electronics unit (→ 6).
Measurement signal continually in the range of 0.5 ... 1.8 V (underrange).	Vacuum chamber pressure < 2×10^{-9} hPa.	–
	Gas discharge has not ignited.	Wait until the gas discharge ignites (≈ 5 minutes at a pressure of 10^{-9} hPa).
Measuring signal unstable.	Gauge contaminated.	Clean the gauge (→ 16).

6 Removing the Gauge From the Vacuum System

DANGER



DANGER: contaminated parts

Contaminated parts can be detrimental to health and environment.

Before you begin to work, find out whether any parts are contaminated. Adhere to the relevant regulations and take the necessary precautions when handling contaminated parts.

Caution



Caution: vacuum component

Dirt and damages impair the function of the vacuum component.

When handling vacuum components, take appropriate measures to ensure cleanliness and prevent damages.

Procedure

- ❶ Deactivate the gauge.
- ❷ Unplug the connector.

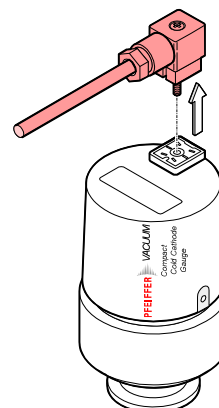

3 Detach the gauge from the vacuum apparatus.

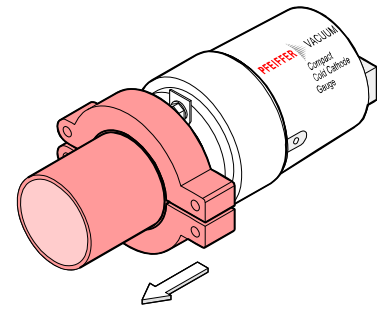

4 Place the protective cap.

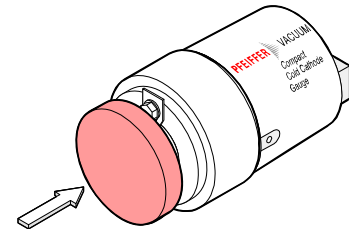

7 Returning the Product



WARNING



WARNING: forwarding contaminated products

Products returned to Pfeiffer Vacuum for service or repair should, if possible, be free of harmful substances (e.g. radioactive, toxic, caustic or microbiological). Otherwise, the type of contamination must be declared.

Adhere to the forwarding regulations of all involved countries and forwarding companies and enclose a completed contamination declaration^{*)}.

^{*)} Form under www.pfeiffer-vacuum.de

Products that are not clearly declared as "free of harmful substances" are decontaminated at the expense of the customer.

8 Accessories

	Ordering number
Cable for connection to Pfeiffer Vacuum measurement unit for Compact Gauges	
3 m	PT 44 850-T
6 m	PT 448 251-T
10 m	PT 448 252-T
Socket Hirschmann GO 6 WF, 6 contacts, angled, female	B 470 7283 MA
Magnetic shielding	PT 443 155-X

9 Spare Parts

Always include the following information with your spare parts order:

- Type of product
- Manufacturing number according to nameplate
- Position, description, and ordering number according to spare parts list

The following parts are available as spare parts sets:

Pos.	Description	Ordering number
12	Maintenance set, consisting of:	BN 846 239-T
11	1× support ring	
10a	1× O-ring FPM75 10.82 × 1.78	
	3× ignition aid	
	1× O-ring FPM75 3.69 × 1.78 (not used with IKR)	
12	Repair set, including:	BN 846 252-T
11	1× support ring	
10	1× anode, complete	
10a	3× ignition aid	
10a	Set of ignition aids, including:	BN 845 995-T
	10× ignition aid	
	Mounting tool for ignition aid	BG 510 600
2	Electronics unit IKR 251	PT 120 160-T
	Measuring system, complete	
	DN 25 ISO-KF flange	BN 846 462-T
	DN 40 ISO-KF flange	BN 846 463-T
	DN 40 CF-F flange	BN 846 464-T
	Exchange gauge (return defective gauge to Pfeiffer Vacuum)	
	DN 25 ISO-KF flange	PT R25 500-A
	DN 40 ISO-KF flange	PT R25 501-A
	DN 40 CF-F flange	PT R25 502-A

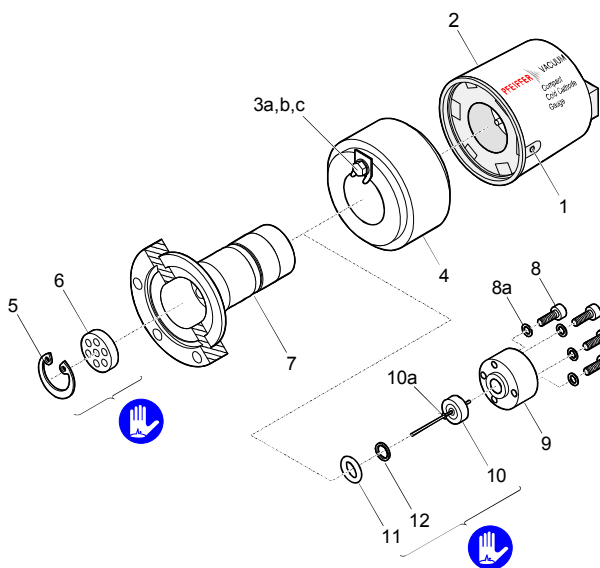

10 Disposal



WARNING



WARNING: substances detrimental to the environment

Products, operating materials etc. may have to be specially disposed of.

For environmentally compatible disposal, please contact your nearest Pfeiffer Vacuum Service Center.

Appendix

A: Conversion Table for Pressure Units

	mbar	bar	Pa	hPa	kPa	Torr mm HG
mbar	1	1×10^{-3}	100	1	0.1	0.75
bar	1×10^3	1	1×10^5	1×10^3	100	750
Pa	0.01	1×10^{-5}	1	0.01	1×10^{-3}	7.5×10^{-3}
hPa	1	1×10^{-3}	100	1	0.1	0.75
kPa	10	0.01	1×10^3	10	1	7.5
Torr mm HG	1.332	1.332×10^{-3}	133.32	1.3332	0.1332	1

$1 \text{ Pa} = 1 \text{ N/m}^2$

B: Measuring Signal vs. Pressure

Conversion formulae

$p = 10^{U-c}$

↔

$U = c + \log_{10} p$

p	U	c
[hPa]	[V]	10.5
[μbar]	[V]	7.5
[Torr]	[V]	10.625
[mTorr]	[V]	7.625
[micron]	[V]	7.625
[Pa]	[V]	8.5
[kPa]	[V]	11.5

where U Measurement signal valid in the range $2 \times 10^{-9} \text{ hPa} < p < 1 \times 10^{-2} \text{ hPa}$
 p Pressure $1.5 \times 10^{-9} \text{ Torr} < p < 7.5 \times 10^{-3} \text{ Torr}$
 c, d Constant (dependent on pressure unit) $2 \times 10^{-7} \text{ Pa} < p < 1 \text{ Pa}$

Conversion curves

Pressure p

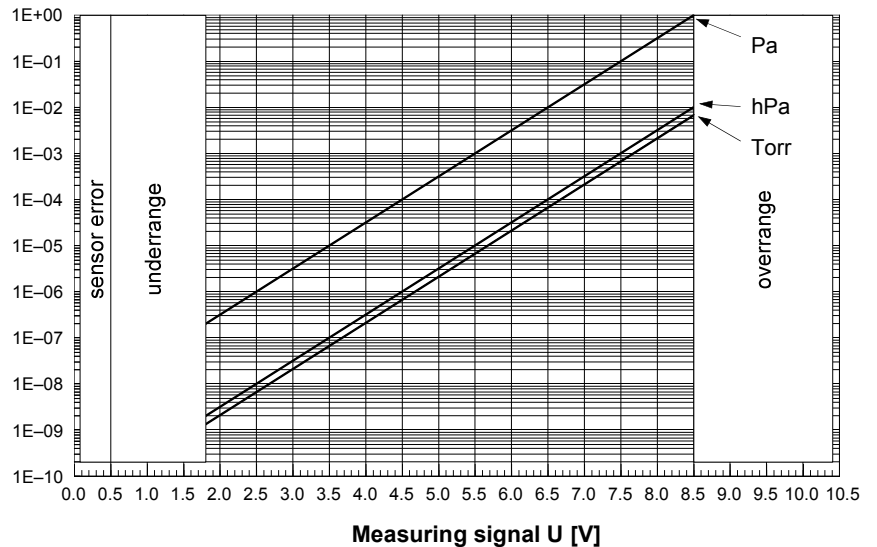

Conversion table

Measuring signal U [V]	[hPa]	Pressure p [Torr]	[Pa]
< 0.5		Sensor error	
0.5 ... 1.8		Underrange	
1.8	2.0×10^{-9}	1.5×10^{-9}	2.0×10^{-7}
2.5	1.0×10^{-8}	7.5×10^{-9}	1.0×10^{-6}
3.5	1.0×10^{-7}	7.5×10^{-8}	1.0×10^{-5}
4.5	1.0×10^{-6}	7.5×10^{-7}	1.0×10^{-4}
5.5	1.0×10^{-5}	7.5×10^{-6}	1.0×10^{-3}
6.5	1.0×10^{-4}	7.5×10^{-5}	1.0×10^{-2}
7.5	1.0×10^{-3}	7.5×10^{-4}	0.1
8.5	1.0×10^{-2}	7.5×10^{-3}	1.0
8.5 ... 10.5		Overrange	

C: Gas Type Dependence

Indicated pressure (gauge calibrated for air)

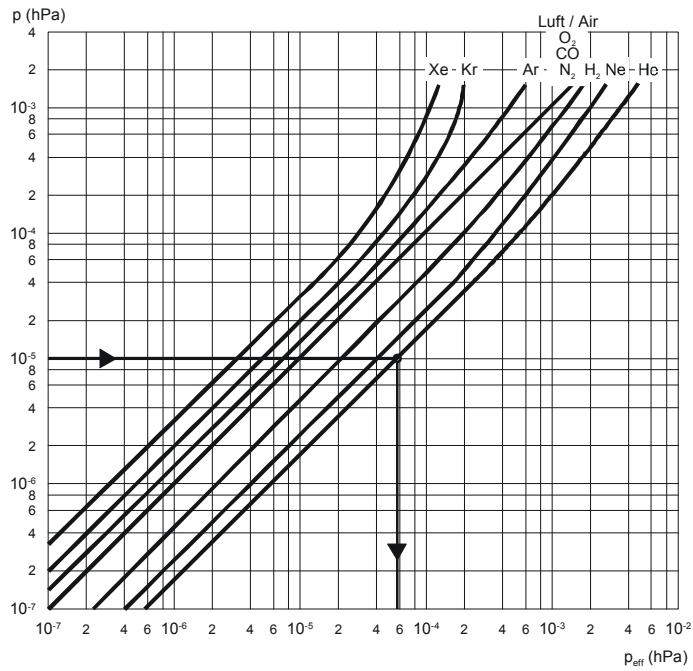

Indication range below 10^{-5} hPa

In the range below 10^{-5} hPa, the pressure indication is linear. For gases other than air, the pressure can be determined by means of a simple conversion formula:

$$p_{\text{eff}} = K \times \text{indicated pressure}$$

where	gas type	K
	air (N ₂ , O ₂ , CO)	1.0
	Xe	0.4
	Kr	0.5
	Ar	0.8
	H ₂	2.4
	Ne	4.1
	He	5.9

These conversion factors are average values.



Caution



A mixture of gases and vapors is often involved. In this case, accurate determination is only possible with a partial pressure measurement instrument, e.g. a quadrupole mass spectrometer.

ETL Certification



ETL LISTED

The product IKR 251

- conforms to the UL Standard UL 61010-1
- is certified to the CAN/CSA Standard C22.2 No. 61010-1

VACUUM SOLUTIONS FROM A SINGLE SOURCE

Pfeiffer Vacuum stands for innovative and custom vacuum solutions worldwide, technological perfection, competent advice and reliable service.

COMPLETE RANGE OF PRODUCTS

From a single component to complex systems:
We are the only supplier of vacuum technology that provides a complete product portfolio.

COMPETENCE IN THEORY AND PRACTICE

Benefit from our know-how and our portfolio of training opportunities!
We can support you with your plant layout and provide first-class on-site-service worldwide.

Are you looking for a
perfect vacuum solution?
Please contact us:

Pfeiffer Vacuum GmbH
Headquarters • Germany
T +49 6441 802-0
info@pfeiffer-vacuum.de

www.pfeiffer-vacuum.com

PFEIFFER  **VACUUM**



bg5151ben/d